

Wiring

- Having correctly identified the wiring from your existing light fitting, pull the mains wire through the hole and connect to the quick fit connection block in the following way.

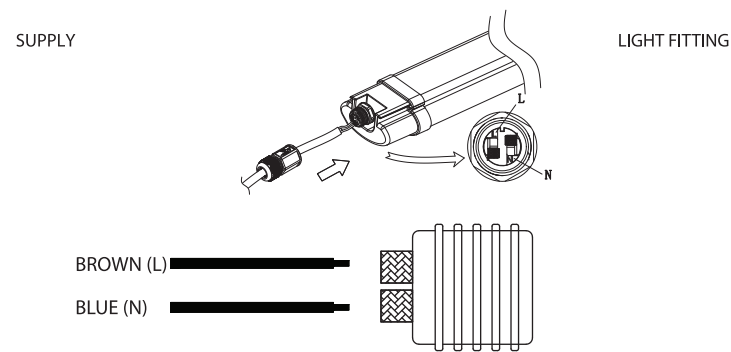

Check that...

- You have correctly identified the wires.
- The connections are tight.
- No loose strands have been left out of the connection block.

Care and Safety

- We recommend cleaning with a soft dry cloth. Do not use solvents or abrasive cleaners as these could damage the finish.
- For your safety, always switch off the power supply before cleaning.

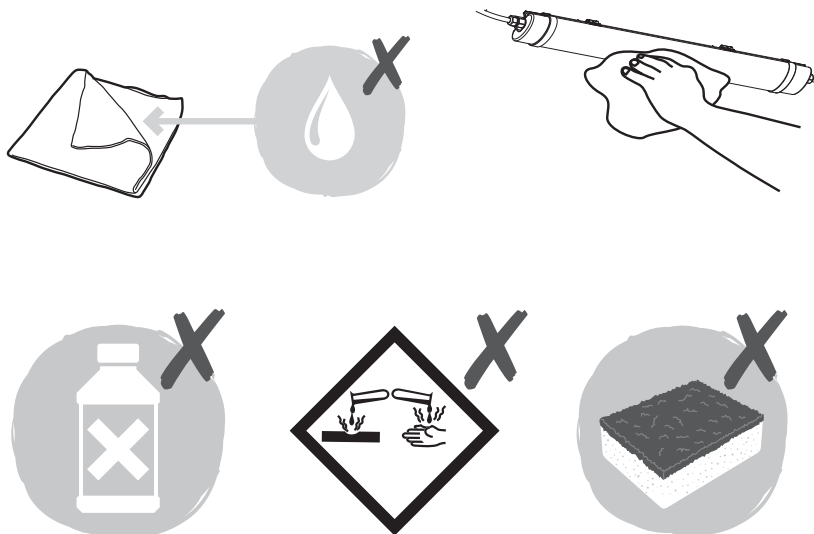

Instruction leaflet

Reeve Connect Batten

75531, 75532, 75533, 75534



V3 29/04/2019

CE

saxby
lighting

Thank you for purchasing this light fitting. Please read the instructions carefully before use to ensure safe and satisfactory operation of this product. Please retain these instructions for future reference.

Warning

Please read these instructions carefully before commencing any work.

This unit must be fitted by a competent and qualified electrician.

Install in accordance with IEE Wiring regulations and current Building Regulations.

Check the pack and make sure you have all of the parts listed.

To prevent electrocution switch off at mains supply before installing or maintaining this fitting.

Ensure other persons cannot restore the electrical supply without your knowledge.

This light fitting should be connected to a circuit with a 30mA RCD fitted.





If replacing an existing fitting, make a careful note of the connections.

We recommend that you use H05RN-F specification cable (not supplied) which is an outdoor grade, rubber sheathed cable. The mains supply cable must have a minimum cross sectional area of 1.0mm²

Cables must be protected using suitable conduit or plastic trunking.

Waste electrical products should not be disposed of with household waste. Please recycle where facilities exist. Check with your local authority or retailer for recycling advice.

Technical data

Supply Voltage:	240 V~, 50 Hz
Bulb Type:	LED (18 W) SMD 2835D 1650lm 6500K - (75531) LED (36 W) SMD 2835D 3700lm 6500K - (75532) LED (45 W) SMD 2835D 4000lm 6500K - (75533) LED (55 W) SMD 2835D 6000lm 6500K - (75534)
	The light source of this luminaire is not replaceable; when the light source reaches its end of life the whole luminaire shall be replaced.
	Conformity with all relevant EC Directive requirements.
	The power supply is Double Insulated and does not require connection to an Earth circuit.
	Waste electrical products should not be disposed of with household waste. Please recycle where facilities exist. Check with your Local Authority or local store for recycling advice.
	This product is not suitable for dimming.
	Caution! Risk of electric shock!
IP65	This product is rated at IP65.

Installation

Existing fittings must be completely removed before installation of a new product. Before removing the existing fitting, carefully note the position of each set of wires.

- Note that the switch is turned off before installation.
- The ceiling surface must be flat and smooth to ensure a good fit.
- Plan the desired layout of this fitting carefully, ensuring the cables will reach the distance between the junction box and the light fitting.
- Avoid locating any cables in positions that would cause a hazard. Position cables and outdoor rated junction boxes (not supplied) away from areas where they may be at risk from being cut, trapped or damaged.
- Refer to the diagram below. Decide on the location of the product. Measure the distance between the mounting bracket location slots, mark the location of the fixing holes on the mounting surface.
- Drill holes and fit supplied wall plugs (suitable for masonry only - for other surfaces use appropriate fixings).
- Attach product to mounting brackets by pushing until securely held.

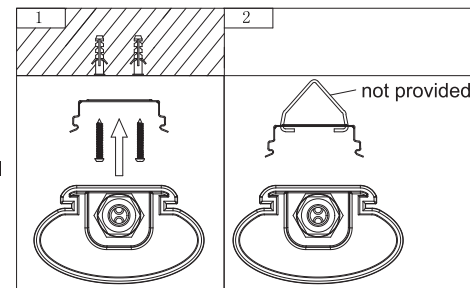
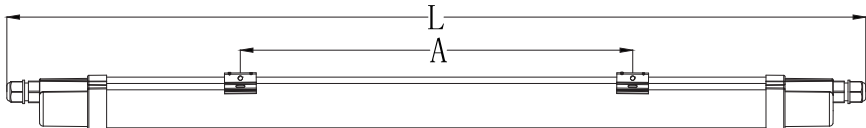
Model	L	W	H1	A	H2
75531	665mm	74mm	42.5mm	300±10mm	49mm
75532	1265mm	74mm	42.5mm	900±10mm	49mm
75533/75534	1565mm	74mm	42.5mm	1200±10mm	49mm

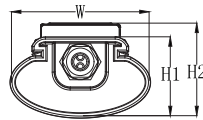

Max number of interconnect with model: 15 pcs -(75531) / 12pcs -(75532)
12 pcs -(75533) / 8pcs -(75534)

